

LIGHTSPACE®
LIGHTING CONTROLS

LT-1203DL Digital Dimmer Pack

User's Manual

BEIJING STARLIGHT ELECTRONICS CO.,LTD

7 Xingguang Road, Xihongmen Town, Daxing District, Beijing 100076

Transportation and Storage Conditions

Delivery - unpacking

Generalities - Safety

Important Notice for Cables

Product Features

Technique Parameters (Product Characteristics)

Installation Requirements

Instruction for front panel

Instruction for rear panel

Cable connection

Operation Instruction

Setup of dimmer parameters

Various check, protection and restore methods

Transportation and Storage Conditions

Severe vibration and collision should be avoided to prevent damage in transportation.

Protection against rain and snow should be provided in transportation and storage.

Storage place should be kept dry, without any conspicuous pollution by erosive, flammable gas, or water vapor, etc.

Stack quantity should be kept within limit to prevent damage.

Temperature range for transportation and storage: 25°C~+55°C

Delivery – unpacking

Upon receipt of LIGHTSPACE[®] products, make sure that the packaging is unopened, and examine your equipment carefully for completeness;

Strict inspection shall be conducted to confirm perfect condition of any equipment before leaving the factory.

If any damage is detected, contact relative parties and keep record.

Verify if delivered products are in conformity with delivery list and the specification of the product series.

Check if the quantity and equipment model are in conformity with the delivery notice;

In the event of any error, contact the shipper immediately to clarify the situation until receiving reply with satisfaction.

If no error is detected, put the product back in the packing and store it at a suitable place for final installation.

Generalities – Safety

LT-1203DL twelve channels digital dimmer Pack is in compliance with Europe safety standard EN60950-1:2006 and EN60204-1:2006. It is categorized as Class I equipment, designed and produced in accordance with relevant safety standards, and provided with compulsory safety grounding by local standards. To prevent any risk of electric shock, do not remove any cover or part of the enclosure. Access to internal parts is not required for normal operation. If damaged, equipment must be repaired and maintained by professional service personnel exclusively. Disconnect from external power supply prior to the opening for inspection or maintenance.

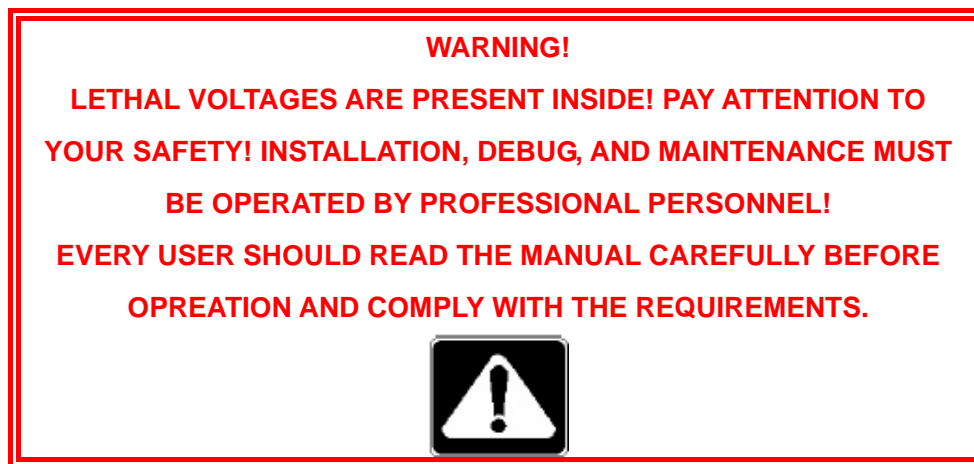

Important Notice for Cables

Power supply cables and connectors are important parts of the safety means for the equipment.

- A main circuit breaker, or fuses shall be provided at the power supply terminal of the cables to cut off the power supply; never touch or contact the power cables;
- Ensure the cable and the connectors are intact, confirm that no damage to the cables exists at each installation and regular checks;
- Do not connect the cables with the signal lines.

Product Features

Fully digital dimming, 12×3kW dimming output

With DMX-512 signal input in accordance with international universal protocol, initial address can be set up at random (1 – 512).

LCD digital indication in English

Professional filter with a rising slope of 150us is provided for each channel to reduce audio and video interference.

Provided with filaments preheating function, MCB overload and short-circuit protection.

Intelligent control of fans and over-temperature alarming

Dimensions(mm): 483(width) ×176(height) ×430(depth)

Weight: 21kg

Integrated design, light weight, easy maintenance

Technique Parameters (Product Characteristics)

Control electronics: fully digital, microprocessor controlled;

Power Ratings: dimmers rated for continuous duty: 12 × 3 kW;

Max power of the whole dimmer Pack is 36kW;

Operation environment: places with temperature ranging from 0~40°C, relative humidity at 25°C less than 90%, no condensation, atmospheric pressure less than 106kP, no erosive or flammable gas and heavy dust, natural ventilation.

Power supply: 3NPE 400V 50HZ TN-S three phase five wire system;

Power supply voltage range: 230V±10%;

Rated supply current: Supplied by star system 3N~ with PE; 60A per phase at 230V;

Dimmer protection: MCB mini breaker (Max. breaking capacity 6000A);

Control signal protocol: DMX-512/1990 USITT

Response time: DMX ≤50ms

Dimmer resolution: 256 steps

Power semiconductors: anti-parallel thyristors;

Min. load per dimmer: ≥60W

DC component in output voltage: below 1V in rated load range;

Types of load: incandescent lamps, tungsten halogen lamps, and transformer-led low voltage lamps;

Color code for supply cable: brown and/or black for phases L1, L2, L3;

Blue for neutral N;

Yellow/green for earth PE;

EMC standard: EMC55015

Safety standard: EN60204-1:2006

EN60950-1:2006

Types of sockets: PHOENIX terminal, SOCEPEX 19 pin socket, Europe SCHUCKO socket, and 32A three pin lighting dedicated socket with earthing are available for client selection.

Protection:

Protection for each dimmer by MCB (breaking capacity 6kA) to ensure safe operation of system under rated conditions;

Cooling: intelligent temperature control fans, and ventilation outlets on both sides.

Installation requirements

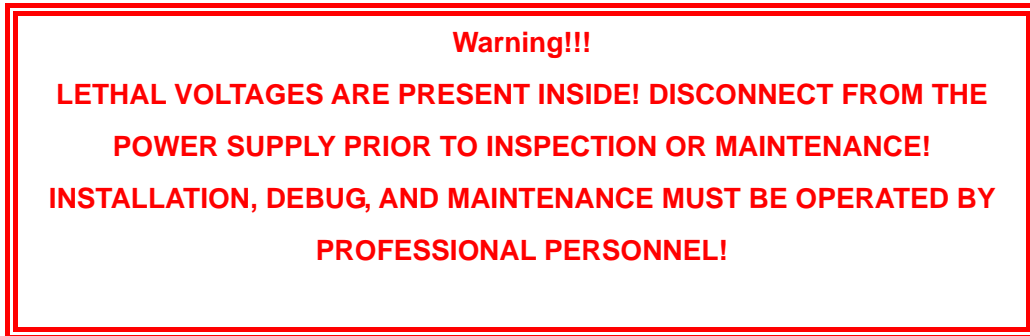

Operation environment of the dimmer Pack should meet the requirements to ensure safe and reliable operation of the product.

Slight squeaks could be generated by dimmer operation. Please confirm if the noise is allowed by the installation environment.

As professional equipment, LT-1203DL must be installed and debugged by professional personnel.

Dimensions(mm): 483(width)×176(height)×430(depth)

Power supply: 3NPE 400V 50HZ TN-S three phase five wire system;

Signal protocol: DMX512/1990 USITT

Installation methods: independently or integrated in cabinet or flight case.

Configuration of the front panel is shown in the following figure.

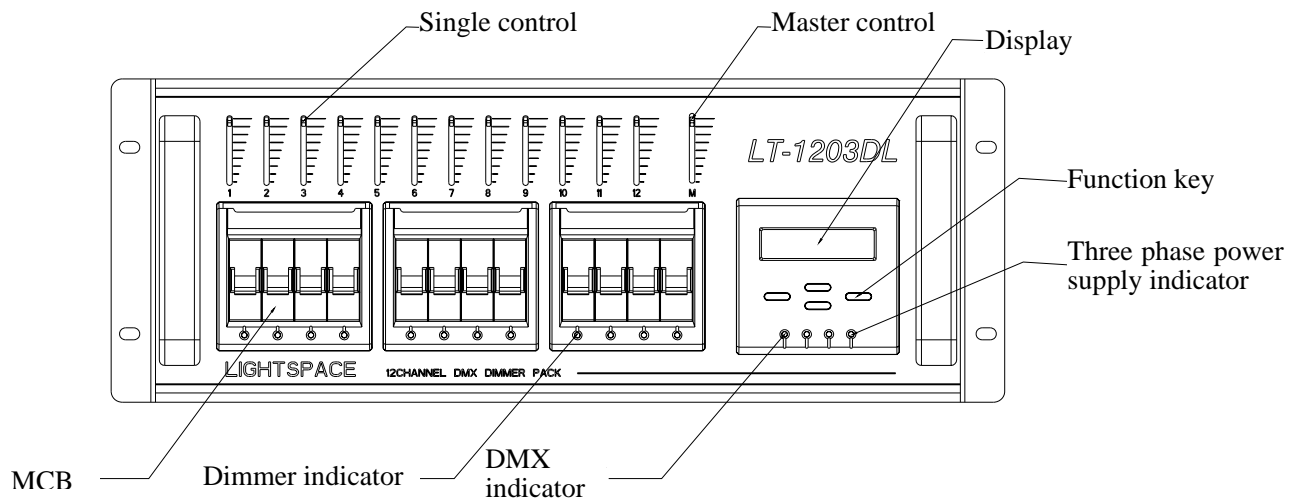

Function keys: consisting of 4 keys in total, namely “SETUP”, “ENTER”, “△”, “▽”.

Three phase indicators: indicating any phase loss of three phase power supply

DMX indicator: indicating DMX signal connection. Without DMX signal, DMX indicator is off; DMX indicator is in red flash when DMX signal is normal; DMX indicator turns green upon receipt of signal, while initial address of this Pack is beyond control range of the dimmer console.

Dimmer indicator: indicating lighting density of each dimmer channel.

Circuit breaker: overload and short-circuit protection.

Single control: control of a single dimmer output.

Master control: control of all output.

Display: setup and status indication.

Configuration of the rear panel is shown in the following figure.

Load terminal:32A three pin lighting dedicated socket

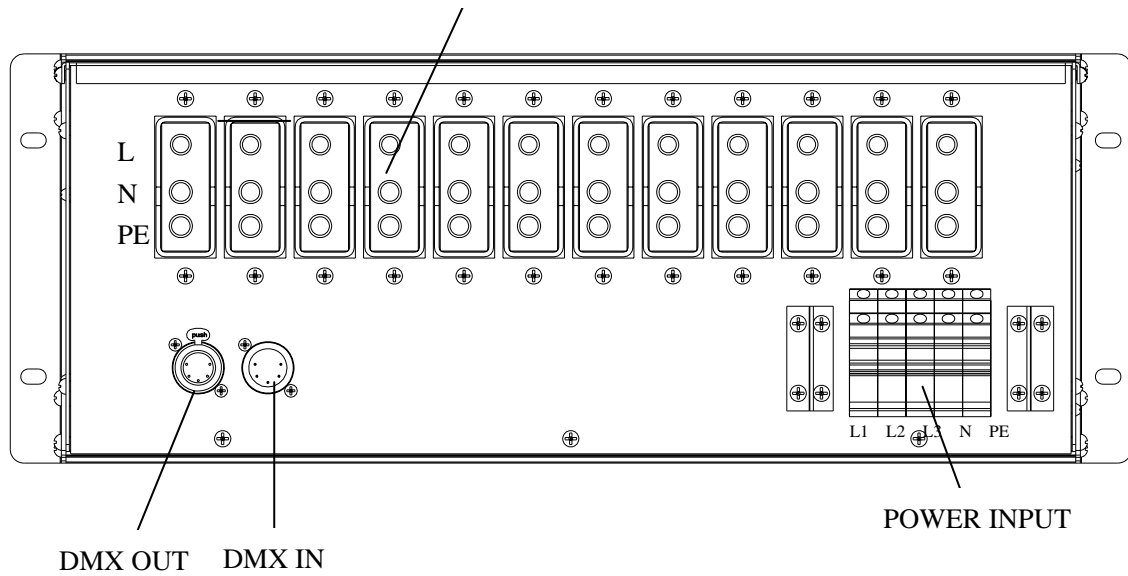

Load terminal: connecting luminaries.

DMX IN:DMX Signal input

DMX OUT:DMX Signal output

POWER INPUT:L1, L2, L3, N, PE correspond with three phase power input, neutral, and protective earth respectively.

Power supply connection

Warning!!!

**Please do not open the cover to prevent electric shock.
If damaged, equipment must be repaired and maintained by professional service personnel exclusively. Disconnect from the power supply prior to the opening for inspection or maintenance.**

A. Type of main supply network

- (1) The standard LT-1203DL is suitable for a three phase 3NPE 400V 50Hz , TN-S system (three phase wires + Neutral wire + earth wire);
- (2) The rated voltage between phase and Neutral is 230V;
- (3) Power supply voltage range: $230V \pm 10\%$;
- (4) LT-1203DL can be operated on a single phase supply.
- (5) For any doubt, consult relevant electrician or utility company;

B. Cable connection requirements

- (1) LT-1203DL and its supply cable must be adequately protected against overload and short-circuit by the installation; verify the current edition of the applicable wiring regulations.
- (2) All connections should be performed by qualified electricians;
- (3) Copper cable with minimum size of 10mm^2 is recommended for power supply connection;
- (4) The color code is blue for Neutral wire (N) and yellow/green for PE;
- (5) The diameter of the Neutral wire must be larger than that of the phases by one order; reduction of the diameter of the Neutral wires is dangerous and strictly prohibited;
- (6) The supply cable should be sized for the rating of LT-1203DL;
- (7) Cables under the current ratings are not allowed.

Warning!!!

**BEFORE ENERGIZING, MAKE SURE THAT NO
SHORT-CIRCUIT AT LOAD SIDE IS FOUND, AND N AND PE
WIRE ARE RELIABLY CONNECTED!!!**

C. Input connection of main power supply

Three phase lines are connected to "POWR INPUT" on the rear panel, L1, L2, L3 terminal are connected with corresponding power source line, N with Neutral line, PE with earthing wire. Refer to the figure of the rear panel.

D. Signal cable connection:

The signal line from dimmer console or last dimmer is connected to XLR connector "IN" labeled as "DMX512" on the rear panel, XLR connector "OUT" is for connection of the next dimmer.

E. Output connection:

Load terminals are for connection with luminaries (take 32A three pin dedicated socket with earthing as an example, its upper pin is connected with the phase line of luminaries, the middle pin is connected with the N line, and the bottom pin is connected with PE).

F. DMX interface Instruction

It is in compliance with international standard DMX512/1990.

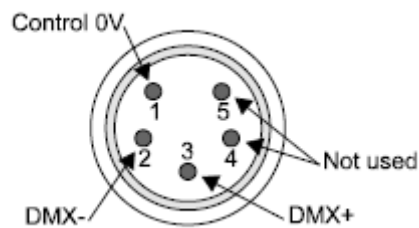

Operation Instruction

LT-1203DL twelve channel digital dimmer Pack is a newly developed light-weight dimmer Pack, compatible with dimmer console and computerized lighting control console with DMX-512 interface. The equipment is provided with master and single control rheostat, either of which can be applied independently. Control signal input or single dimmer control rheostat are subject to the principle that highest takes precedence.

1. Independent application: first push faders for master control and single control rheostat to minimum position, close circuit breakers for each dimmer channel, then position combination of faders for mater control and single control can be used to control lighting density of each dimmer.
2. On-line application: dimmers can be connected on-line with dimmer console via on-line terminal. First set up initial address of the dimmer channel via front panel function key, set faders for master control and single control rheostat to minimum position, close circuit breakers, then lighting density of each dimmer can be controlled by dimmer console.

Set-up of dimmer parameters

When power is turned on, LCD display on the rear panel indicates: (Figure 1) initial address number of the dimmer, internal temperature, and lighting density of each dimmer (light column indication).

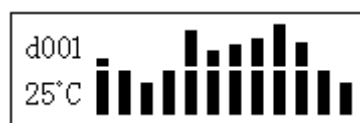

(Figure 1)

Under normal operation condition, press “SETUP” key to enter the setup menu. Setup menu includes six configurations in the order of precedence: 1. DMX start addr; 2. Set preheat; 3. Check fan; 4. Check Dimmer; 5. Set Out Mode; 6 Set Law.

1. Set DMX start address of the dimmer:

Press “SETUP” key to enter the interface for DMX Start address setup, with LCD display (figure 2)

```
DMX start addr
NO: 001
```

(Figure 2)

Press “△”or “▽” key, start address number will add or deduct 1; Press “△”or “▽” key continuously to add or deduct rapidly (maximum number can be set to be 512). The final number displayed is the DMX start address number of the dimmer.

2. Set preheat value of filaments

Press “SETUP” key to enter the interface for preheat value setup, with LCD display (figure 3)

```
Set Preheat
NO: off
```

(Figure 3)

(OFF indicates that the function is shut down.) Press “△”or “▽” key to select preheat value of filaments. Preheat value ranges from 01 to 10. OFF indicates that preheat function is shut down.

For example: preheat value of light filaments is selected as 02, with LCD display (figure 4)

```
Set Preheat
NO: 02
```

(Figure 4)

If the preheat value is selected, the dimmer will provide preheat output according to the preset value in case there is no control signal after turning on.

3. Internal temperature and fan checking:

Internal fans are provided for intelligent temperature control. They start up automatically when internal temperature is over 55°C.

The fans stop automatically when internal temperature is below 45°C.

Press “SETUP” key to enter the interface for temperature indication and fan check, with LCD display (figure 5).

```
Check fan
Temp:19°C Fan:OFF
```

(Figure 5)

(Temp: 29°C indicates internal temperature) Press “△” to start fans and check their working conditions. (Figure 6)

```
Check fan
Temp:19°C Fan:ON
```

(Figure 6)

Press “▽” to shut down (Figure 5);

In case that environment temperature is so high that fans are damaged and internal temperature gets over 75°C, the display will flash to show the current temperature. Under such circumstance, it is necessary to reduce load or shut down some dimmers to prevent damage on the equipment; When the temperature is below 75°C, the display returns back to normal indication of Pack number. If internal temperature is above 80°C, the system will automatically reduce output of each channel by 50% (Direct-through output remains the same).

4. Check channels:

Press "SETUP" key to enter the interface for dimmer channel check, LCD display (figure 7)

```
Check Dimmer
Press <ENTER>
```

(Figure 7)

Press “ENTER” key to enter the check menu. (Figure 8)

```
Check Dimmer
DIM:01 level:00
```

(Figure 8)

Press “△” or “▽” to adjust the output level of dimmer 1, the output level ranges from 00 to FL. Press “ENTER” key to check the output level of dimmer 2. Press “ENTER” key again to continue checking the output level of dimmers 3 to 12 and ALL.

5. Setup of output mode:

Press “SETUP” key to enter the interface for output mode setup, with LCD display (figure 9)

```
Set Out Mode
Press: <ENTER>
```

(Figure 9)

Press “ENTER” key to enter the output mode selection menu. (Figure 10, Figure 11)

```
Set Out Mode
Dim:01 Mode:SW
```

(Figure 10)

```
Set Out Mode
Dim:01 Mode:DIM
```

(Figure 11)

Press “△” or “▽” key to set dimmer channel 1 to switching mode (SW) or dimming mode (DIM). Press “ENTER” key again to set output mode for next dimmer channel (2 ~ 12) and all dimmers.

6. Set dimming law:

Press “SETUP” key to enter the interface for dimming law setup. Four modes are available for different dimming requirements. When LCD indicates “Gently” (figure 12)

```
Set Law
Law: Gently
```

(Figure 12)

The output voltage level of the dimmer is increasing slowly, as shown by Figure

12A.

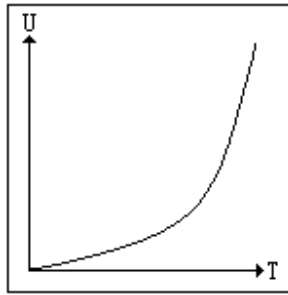

(Figure 12A)

Press "▽" key to select next dimming law, LCD indicates "Square" (figure 13)

```
Set Law
Law: Square
```

(Figure 13)

The output voltage level of the dimmer is at square working status, as shown by Figure 13A

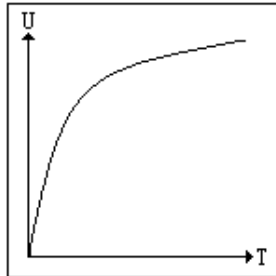

(Figure 13A)

Press "▽" key to select next dimming law, LCD indicates "Linear" (figure 14)

```
Set Law
Law: Linear
```

(Figure 14)

The output voltage level of the dimmer is at linear working status, as shown by Figure 14A

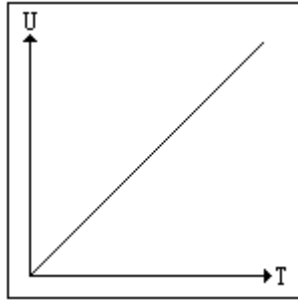

(Figure 14A)

Press "▽" key to select next dimming law, LCD indicates "Normal" (figure 15)

```
Set Law
Law: Normal
```

(Figure 15)

The output voltage level of the dimmer is at S curve status, as shown by Figure 15A

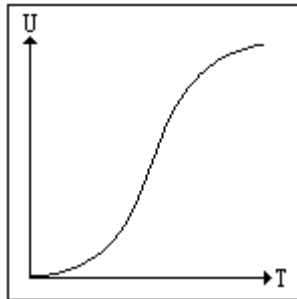

(Figure 15A)

Various check, protection, restore methods

Warning!!!
HIGH VOLTAGES ARE PRESENT INSIDE! DANGER!!! PAY
ATTENTION TO YOUR SAFETY!
INSTALLATION, DEBUG, AND MAINTENANCE MUST BE
OPERATED BY PROFESSIONAL PERSONNEL!

- A.** To prevent electric shock please do not open the cover. In case of any damage to equipment, inspection or maintenance shall be conducted by professional personnel. Make sure power supply is disconnected before inspection and maintenance.
- B.** Check main supply voltage before connecting equipment. If above the rated voltage, internal control module may be damaged.
- C.** If lighting density of a dimmer channel cannot return to zero, and can be increased by dimmer console, please check if the single control and preheat function are set zero.
- D.** If luminaries are normally off without control, while dimmer indicator indicates normal, please check if circuit breakers are in open position or overloaded.
- E.** If luminaries is normally on without control, while dimmer indicator indicates normal, rectifier or other control modules may be damaged.
- F.** If DMX indicator indicates abnormal condition, please check if the communication connection is correct and if the dimmer console is working normal.
- G.** If phase line indicator is off, please check if the three phase lines are connected correctly.
- H.** In case of abnormal switch-off of MCB: close the switch again to check if the circuit is electrified. If not, a short circuit shall exist, and then check the circuit; If MCB trips again after being closed for some time, please check if an overload exists.
- I.** Check working condition of fans regularly.

Notice:

- (1) Contact our company for maintenance, which should be carried out following the guidance of professional engineers;
- (2) Since lethal voltage is present in the equipment, repair shall be conducted by trained professionals;
- (3) Disconnect external power supply before opening the cover;
- (4) Disconnect external power supply before changing fuses F1A (5 x 20 mm) on

power supply board; thorough check around fuses should be made to detect damage to fuses and possible malfunction of other components.

- (5) Contact the supplier if components are to be changed.

User's Manual for LT-1203DL Digital Dimmer Pack, Second Edition, 2009

BEIJING STARLIGHT ELECTRONICS CO., LTD

Copy right of Starlight Electronics Co., subject to change without prior notice.

BEIJING STARLIGHT ELECTRONICS CO.,LTD

7 Xingguang Road, Xihongmen Town, Daxing District, Beijing 100076

Tel: 010-60259548 60259546

FAX:010-60259757

E-mail: mail@lightspace.com.cn

<http://www.lightspace.com.cn>

please contacts our company for technique support.